

4362

COLOURWAYS

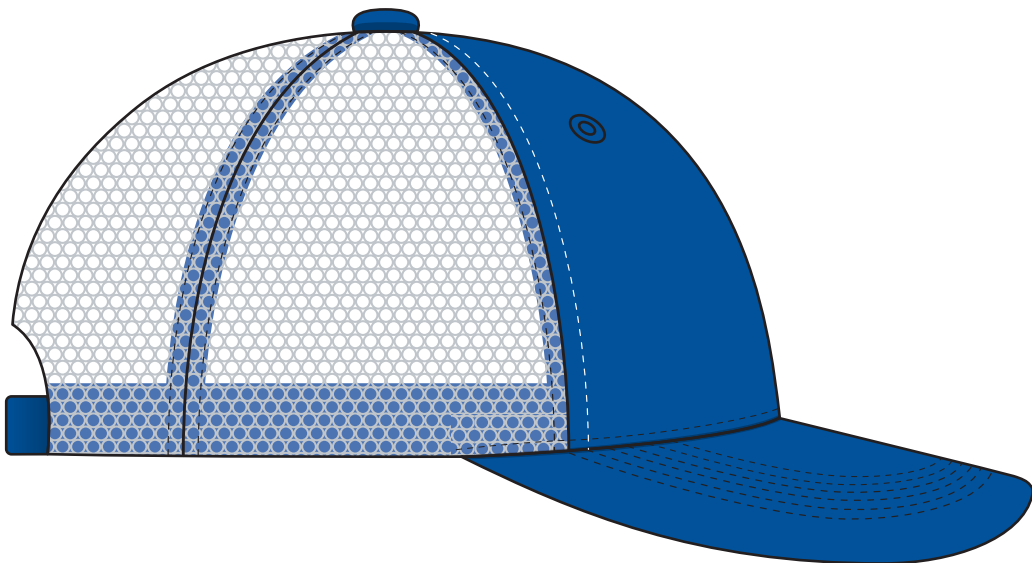

COLOUR

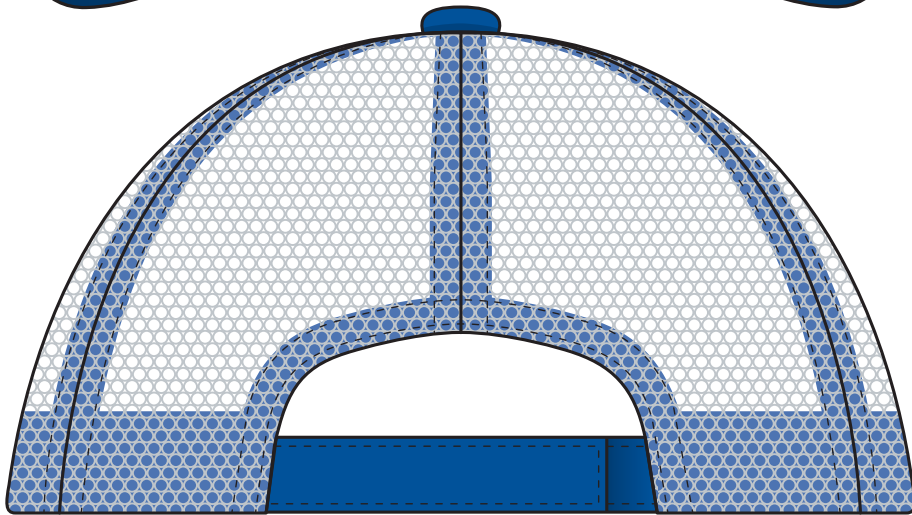
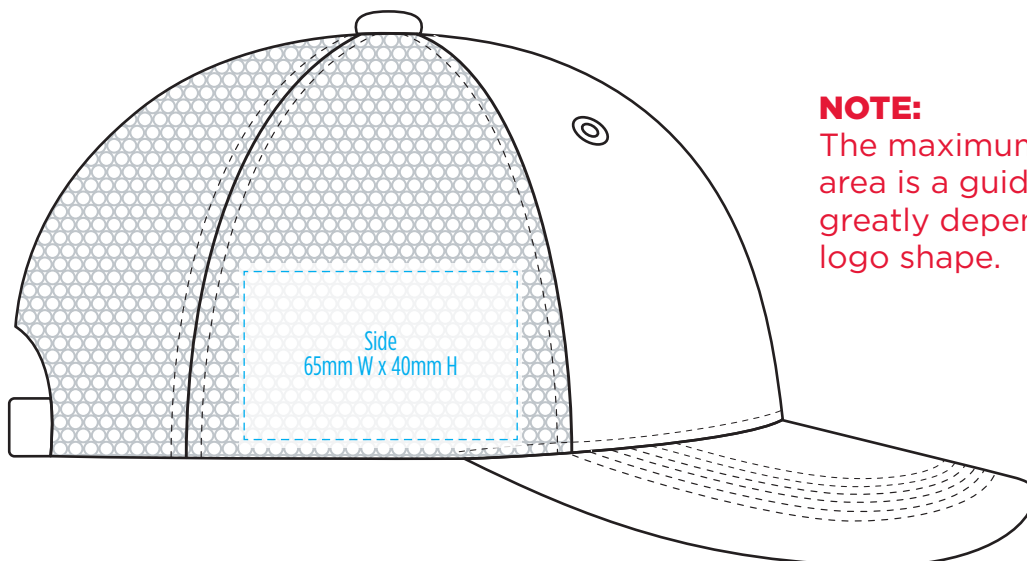
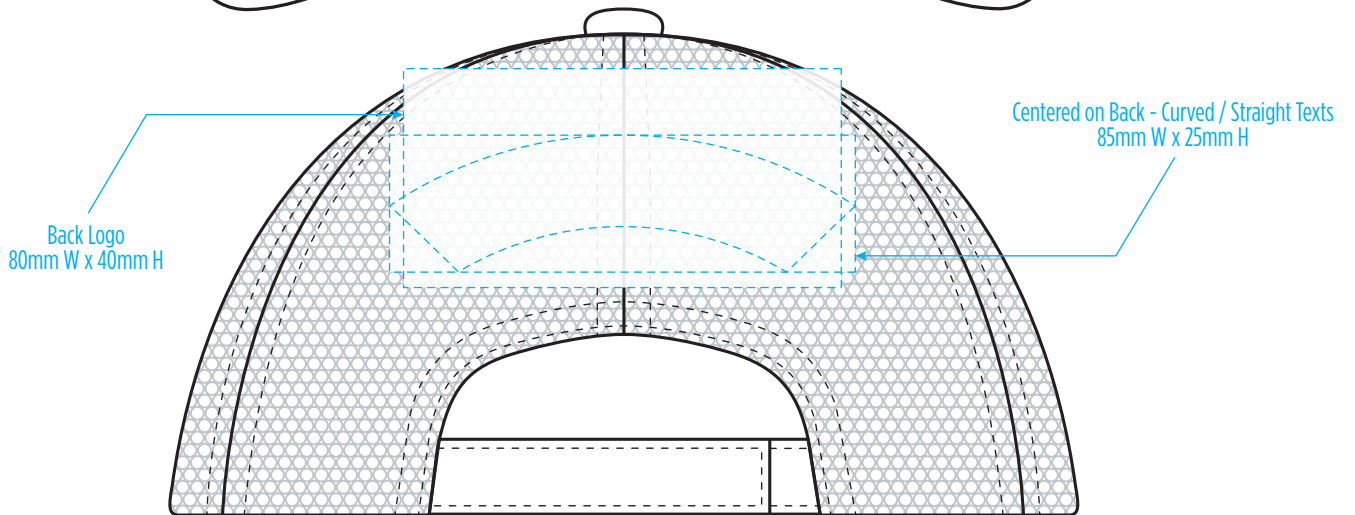
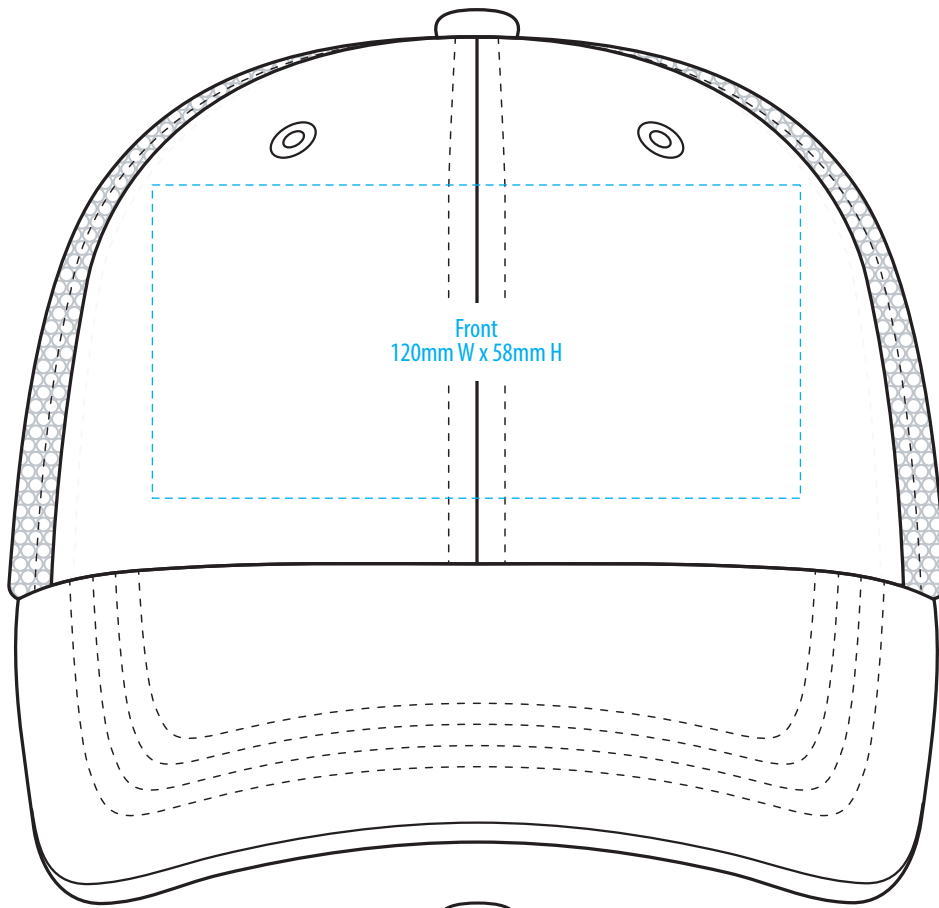

NOTE:
The maximum decoration area is a guide only and is greatly dependant on the logo shape.

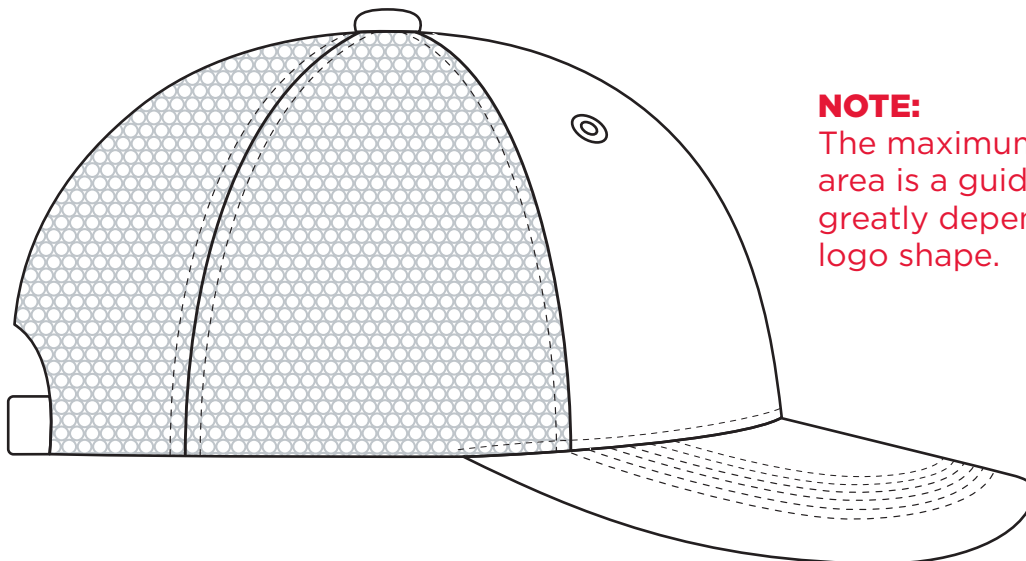
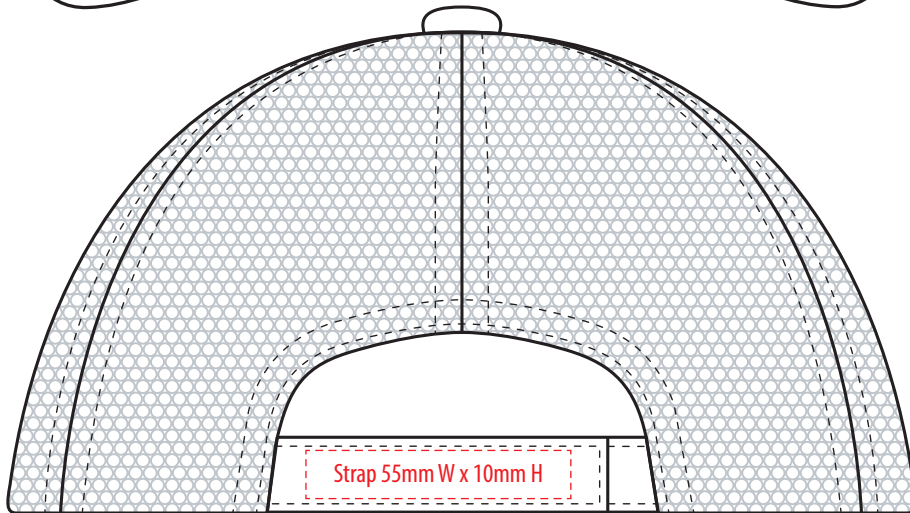
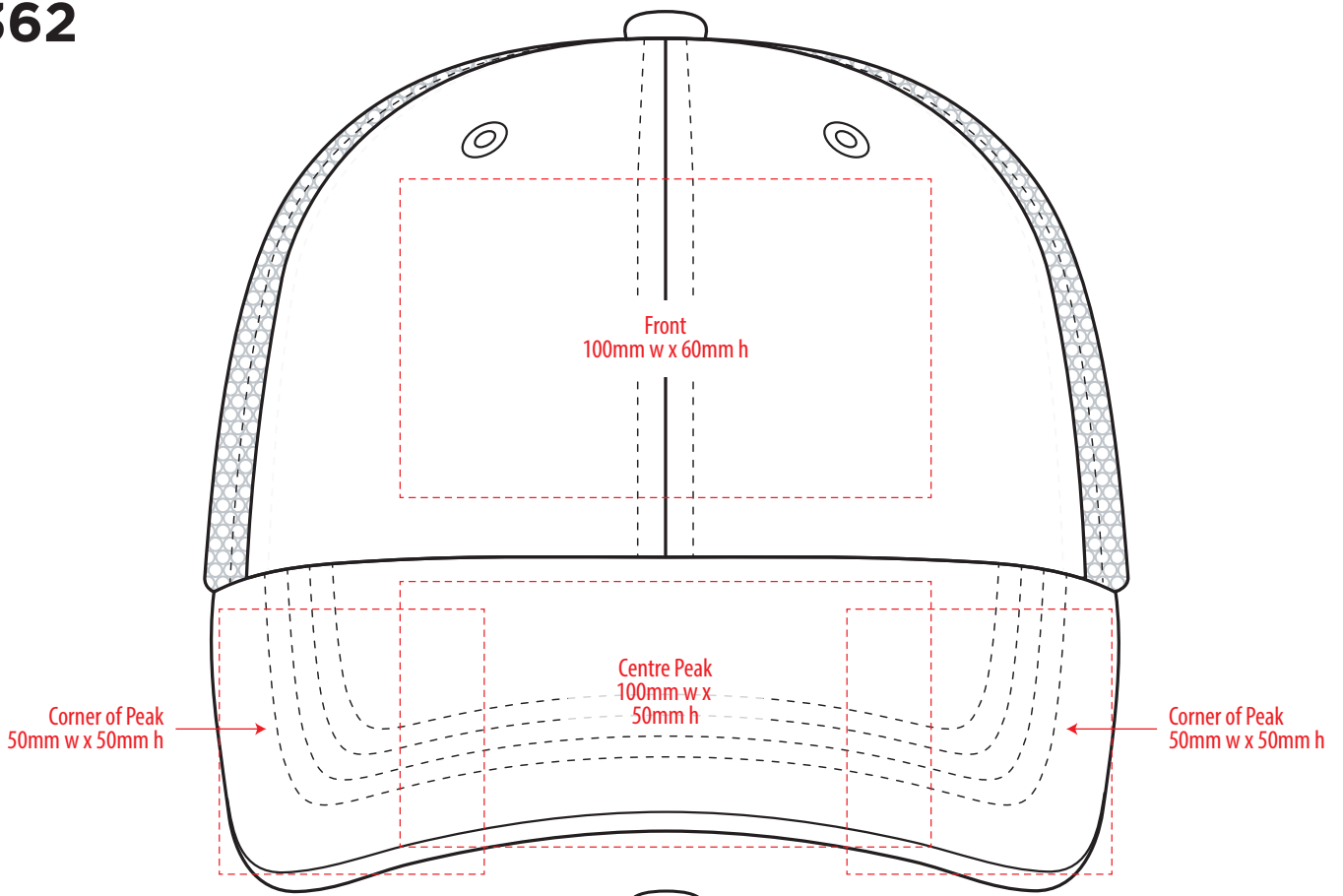

NOTE:
The maximum decoration area is a guide only and is greatly dependant on the logo shape.

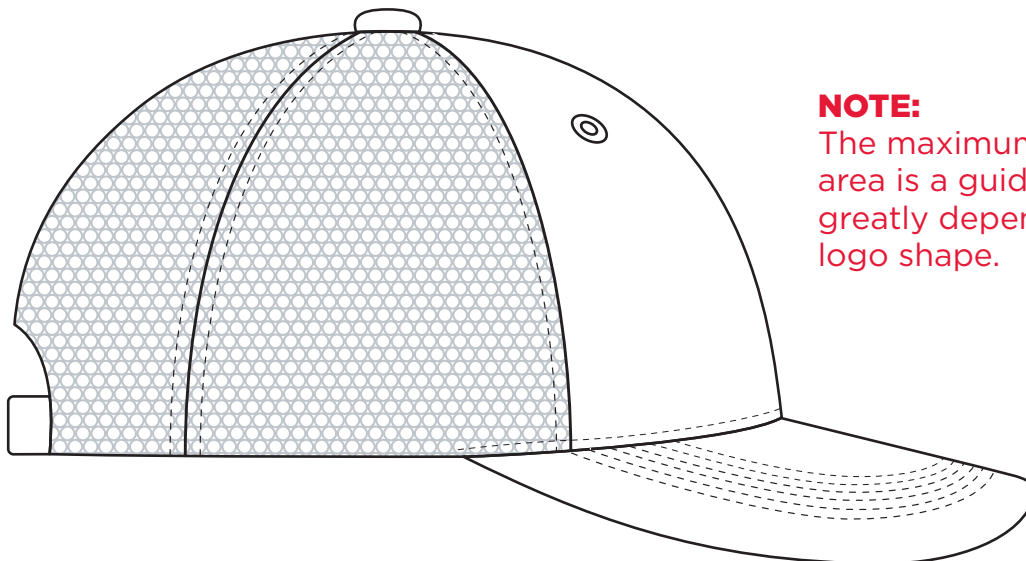
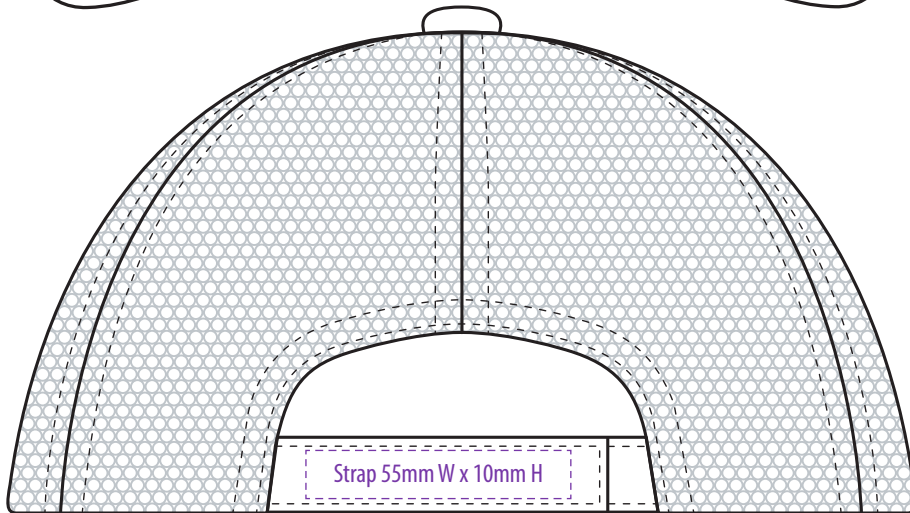
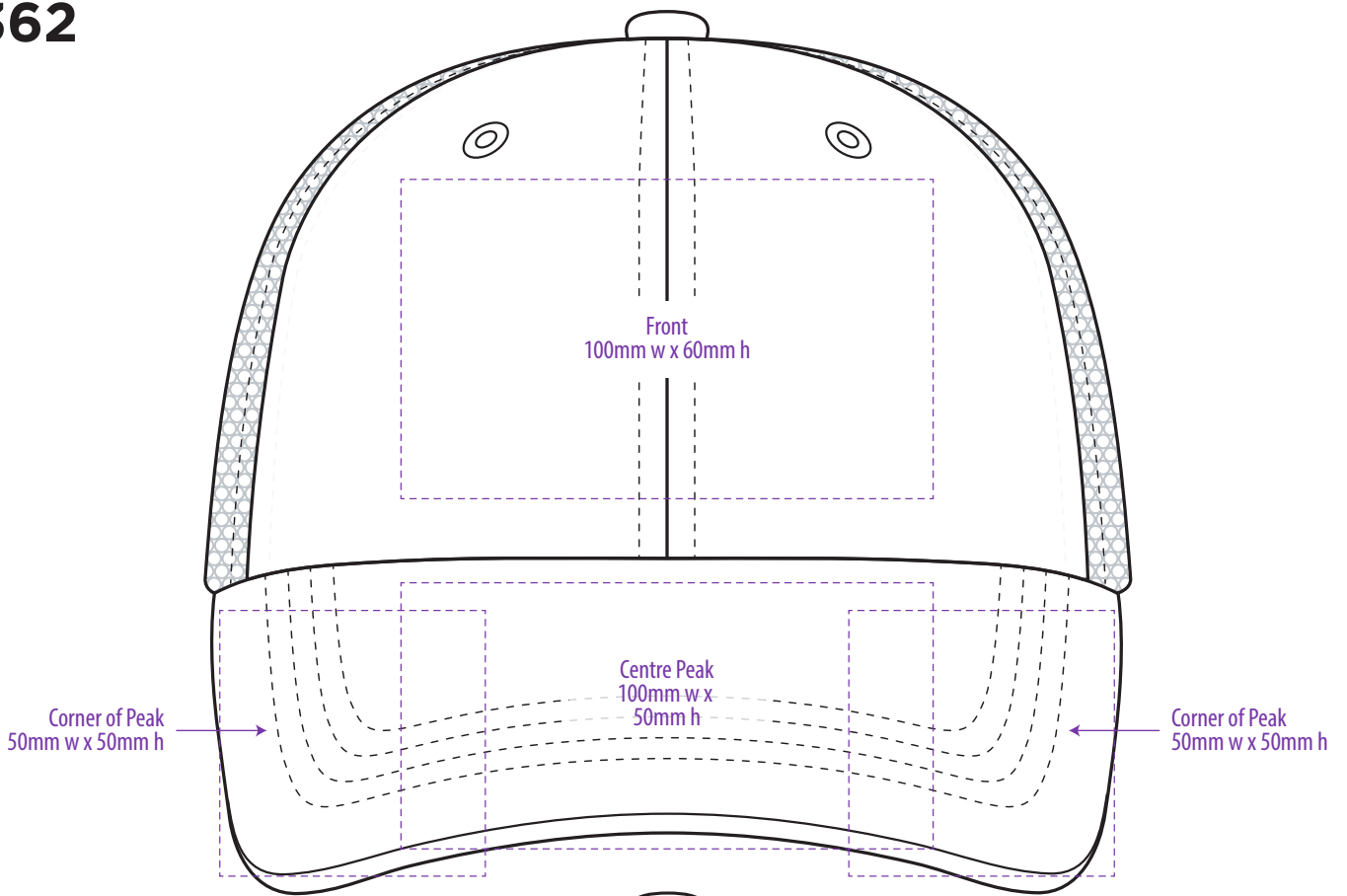

NOTE:
The maximum decoration area is a guide only and is greatly dependant on the logo shape.

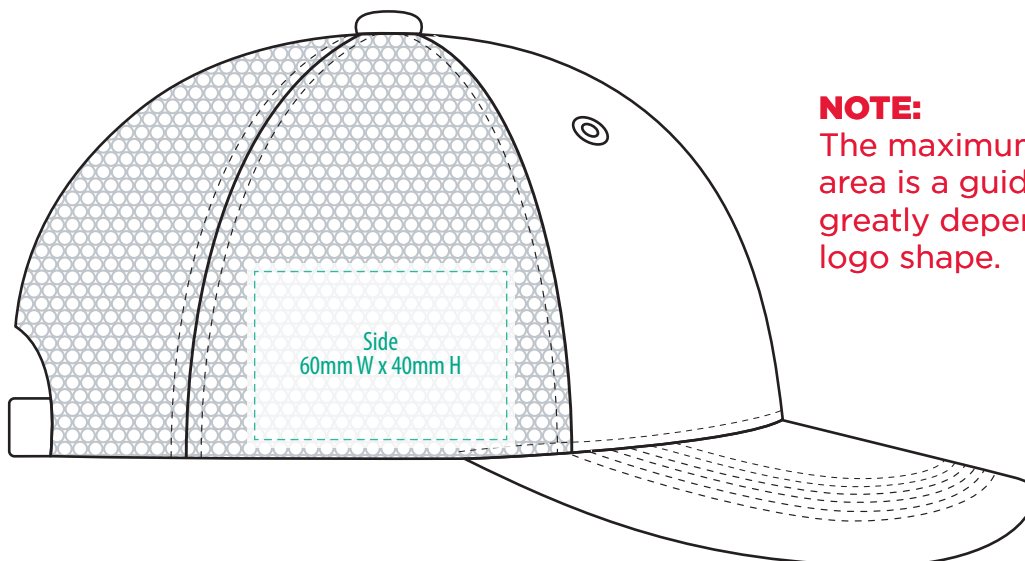
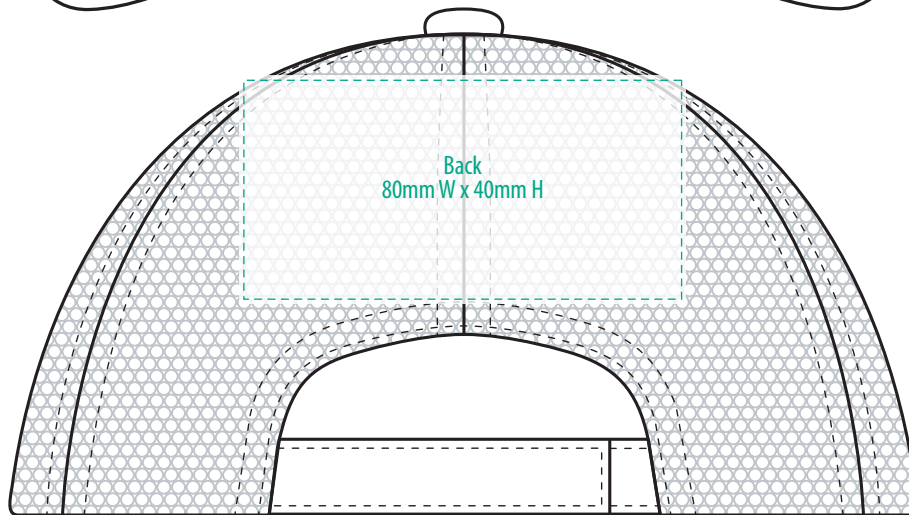
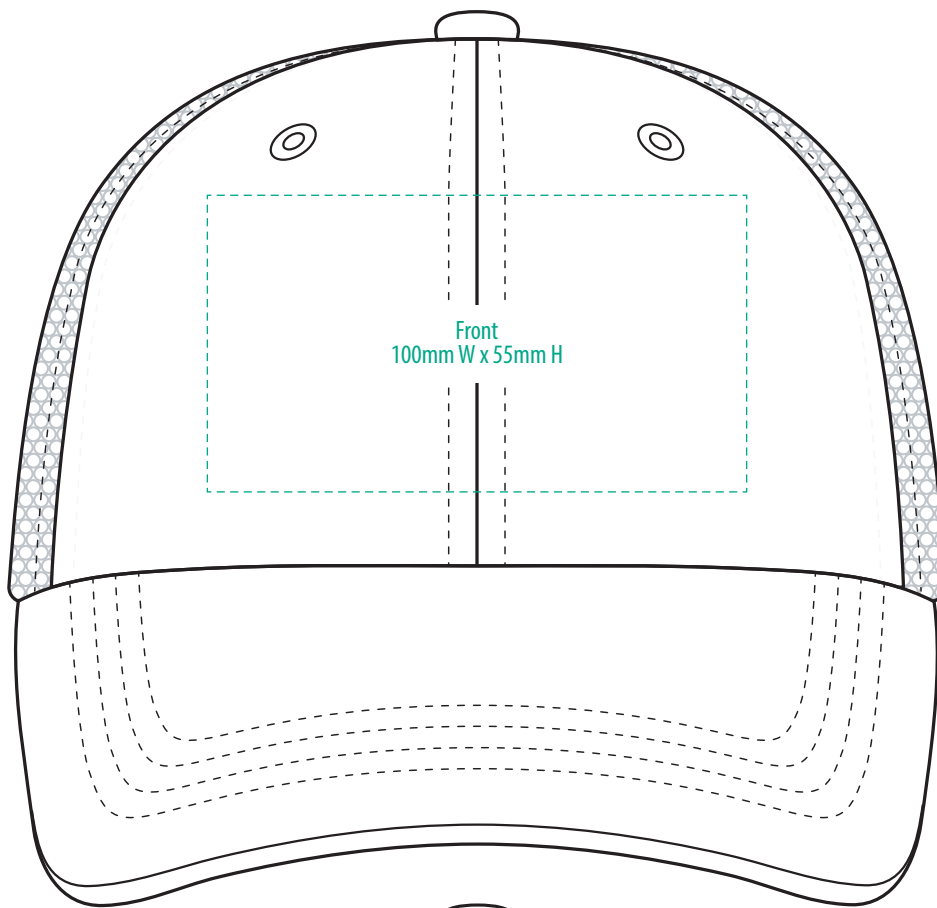









NOTE:
The maximum decoration area is a guide only and is greatly dependant on the logo shape.

SUPASUB / SUPAETCH / SUPAFLEX

[PATCH MUST BE AT LEAST 25MM X 25MM]

4362

FABRIC SWATCH

| | | | | |
|-----------------------|---|------------|--|--------------------|
| BLACK/CHARCOAL |  | BLACK |  | PMS Cool Grey 10 C |
| NAVY/SILVER |  | PMS 2965 C |  | PMS Cool Grey 5 C |
| RED/CHARCOAL |  | PMS 186 C |  | PMS Cool Grey 10 C |
| ROYAL/SILVER |  | PMS 287 C |  | PMS Cool Grey 5 C |

Pantone colours are provided as a reference only and are based on closest match. Actual product colour may differ. If a precise colour match is required we recommend ordering a sample.